

# Portable Gantry Crane

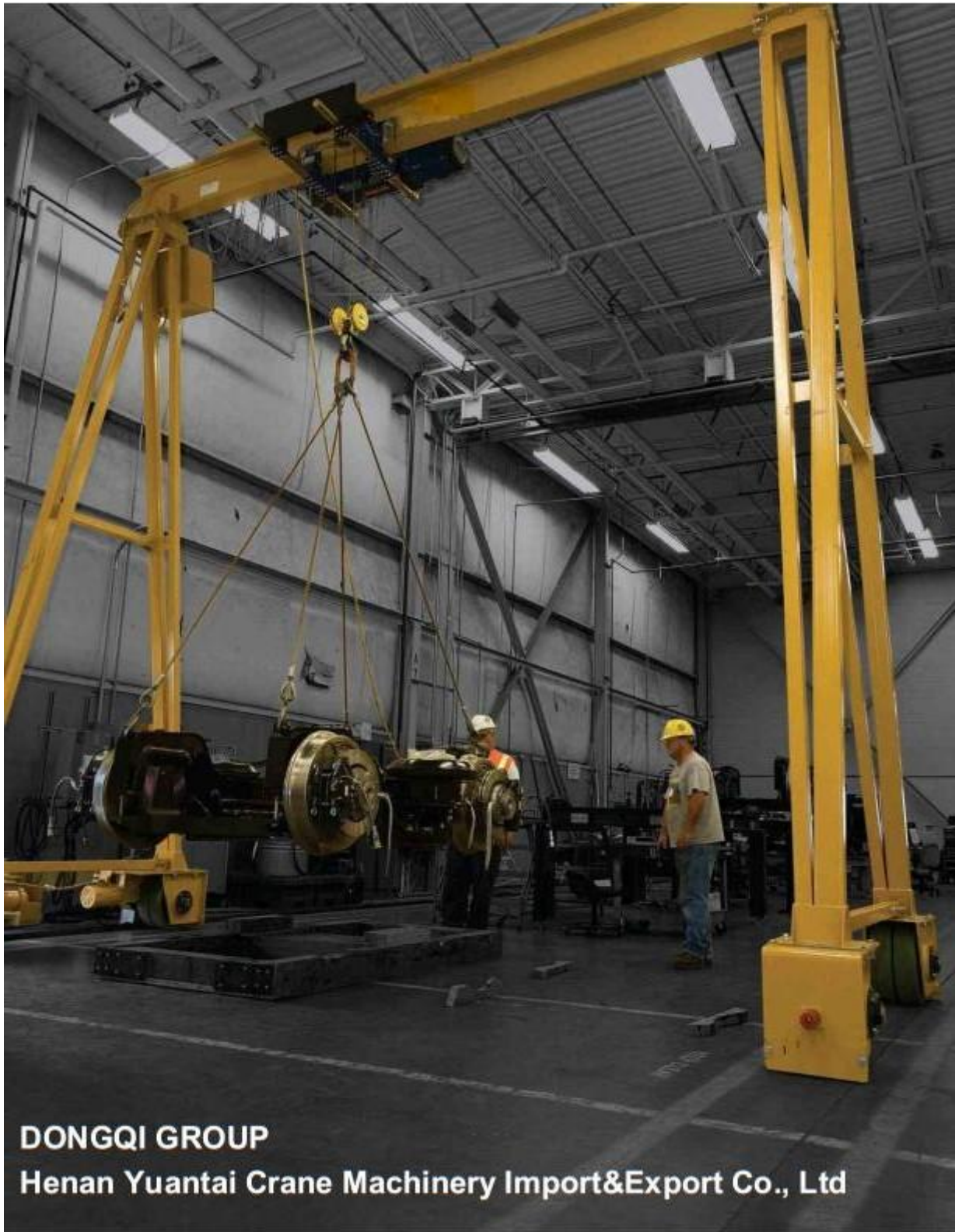

**DONGQI GROUP**

**Henan Yuantai Crane Machinery Import&Export Co., Ltd**

Portable gantry crane is a kind of small lifting equipment, which has the characteristics of simple structure, small occupancy space, flexible assembly and affordable price. It is widely used in factory equipment installation and maintenance, production line cargo handling, outdoor cargo loading and unloading scenes etc.

# 1. Main Parameters

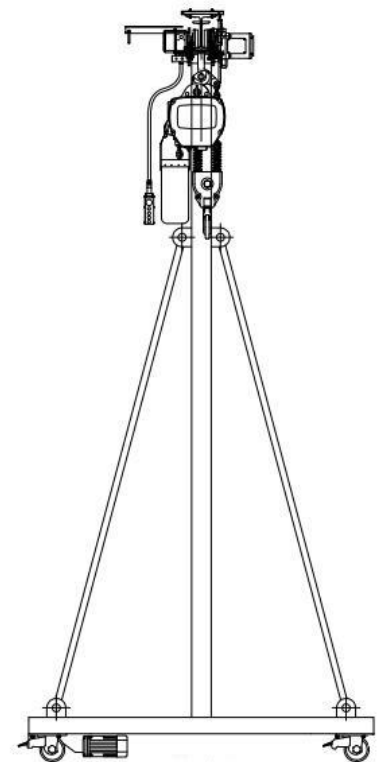
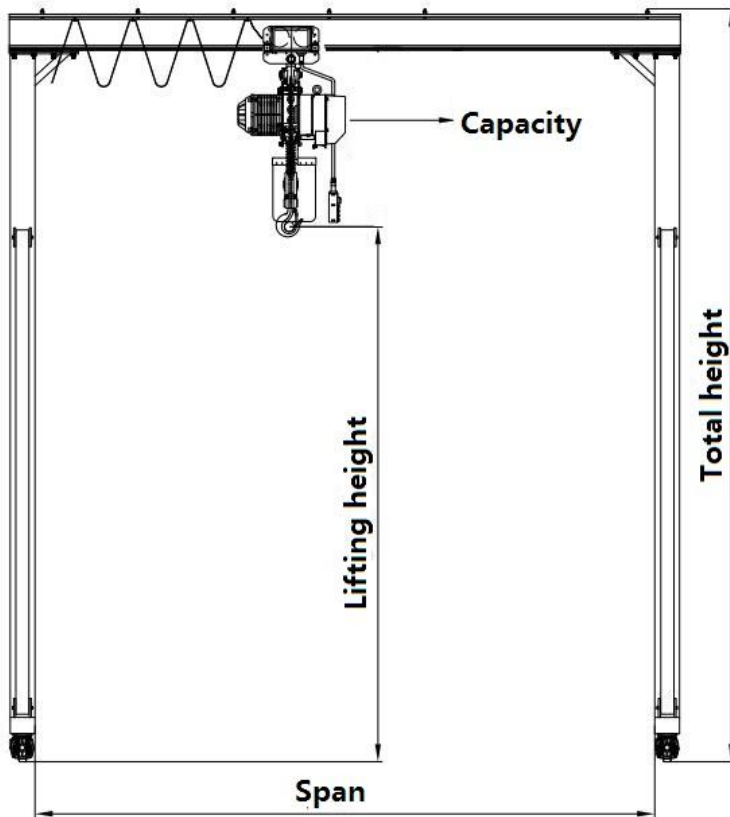

|                             |   |  |
|-----------------------------|---|--|
| Capacity                    | t | ?  |
| Span                        | m | ?  |
| Lifting height/total height | m | ?  |
| Hoist type                  | / | Manual hoist/<br>Electric chain hoist/<br>Electric wire rope hoist |
| Crane travelling            | / | Fixed supporting leg/<br>Manual traveling/<br>Motorized travelling |
| Control method              | / | Pendant control/<br>Remote control                                 |

## 2. Models and characteristics

Model: PT1



1. Manual hoist & trolley
2. Manual crane travelling
3. No site limitation
4. Standard profile steel

### Technical Parameters

| Model | Max Capacity | Max Height | Max Span  | Hoist Type                      | Crane Travelling        |
|-------|--------------|------------|-----------|---------------------------------|-------------------------|
| PT-1  | 20 tons      | 10 meters  | 10 meters | Manual chain block with trolley | Manual universal wheels |

Model: PT2



1. Electric hoist with motorized trolley
2. Manual crane travelling
3. Easy to operate

## Technical Parameters

| Model | Max Capacity | Max Height | Max Span  | Hoist Type                            | Crane Travelling        |
|-------|--------------|------------|-----------|---------------------------------------|-------------------------|
| PT-2  | 20 tons      | 12 meters  | 12 meters | Electric hoist with motorized trolley | Manual universal wheels |

Model: PT3

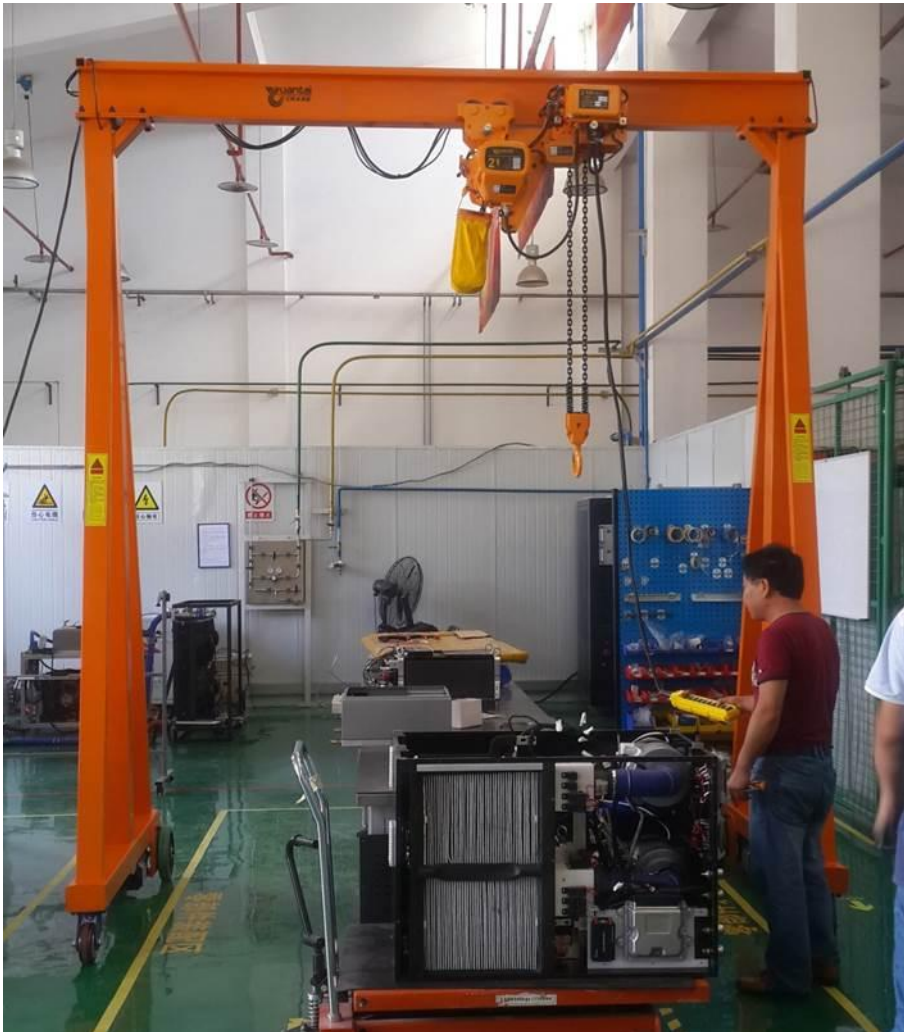

1. Electric hoist with motorized trolley
2. Motorized crane travelling
3. Electric turning mode

## Technical Parameters

| Model | Max Capacity | Max Height | Max Span  | Hoist Type                            | Crane Travelling           |
|-------|--------------|------------|-----------|---------------------------------------|----------------------------|
| PT-3  | 20 tons      | 12 meters  | 12 meters | Electric hoist with motorized trolley | Motorized universal wheels |

Model: PT4



1. Electric hoist with motorized trolley
2. Adjustable supporting legs

## Technical Parameters

| Model | Max Capacity | Max Height | Max Span  | Hoist Type                            | Crane Travelling                     |
|-------|--------------|------------|-----------|---------------------------------------|--------------------------------------|
| PT-4  | 10 tons      | 12 meters  | 12 meters | Electric hoist with motorized trolley | Manual or motorized universal wheels |

Model: PT5



1. Electric hoist with motorized trolley
2. Motorized crane travelling
3. Rail-mounted crane travelling

## Technical Parameters

| Model | Max Capacity | Max Height | Max Span  | Hoist Type                            | Crane Travelling                    |
|-------|--------------|------------|-----------|---------------------------------------|-------------------------------------|
| PT-5  | 20 tons      | 10 meters  | 15 meters | Electric hoist with motorized trolley | Rail-mounted motorized steel wheels |

Model: LT-1



1. Aluminium alloy structure
2. Light weight
3. Easy assemble and disassemble



## Technical Parameters

| Model | Max Capacity | Max Height | Max Span | Hoist Type           | Crane Travelling        |
|-------|--------------|------------|----------|----------------------|-------------------------|
| LT-1  | 5 tons       | 8 meters   | 8 meters | Electrical or manual | Manual universal wheels |



Model: LT-2







1. Aluminium alloy structure
2. Light weight
3. Adjustable span

### Technical Parameters

| Model | Max Capacity | Max Height | Max Span | Hoist Type           | Crane Travelling     |
|-------|--------------|------------|----------|----------------------|----------------------|
| LT-2  | 5 tons       | 8 meters   | 8 meters | Electrical or manual | Fixed supporting leg |

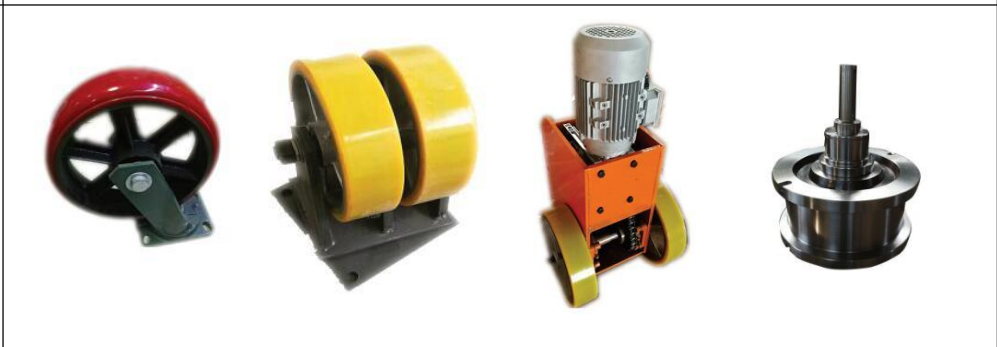
### 3. Detailed parts

|                       |  |
|-----------------------|--|
| <p>Hoist</p>          |    |
| <p>Main structure</p> |   |
| <p>Wheels</p>         |  |
| <p>Control</p>        |  |

## 4. Applications scenarios

